

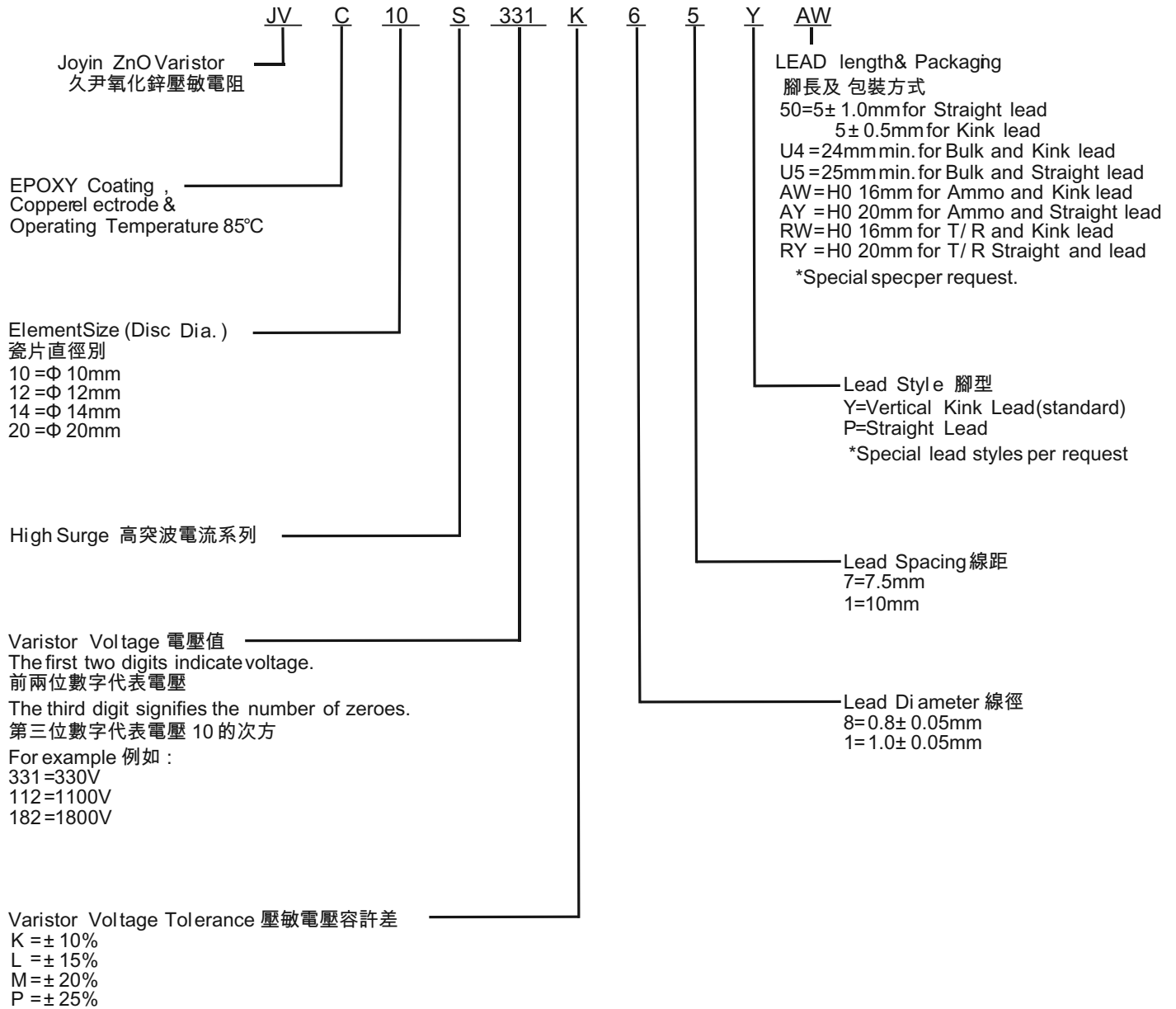

ORDERING CODE



過電壓保護

Application notes for UL ,CSA ,VDE and CQC reconized related standards

Standard NO.	UL	CUL	VDE		CQC	
	UL 1449 4 TH Edition	CSA 22.2 No. 269.5	IEC61051-1 IEC61051-2 IEC61051-2-2	IEC61051-1 IEC61051-2 IEC61051-2-2 IEC60950-1:2013 Annex Q IEC62368-1: 2014 / G.8.2	GB/T1093-1997 GB/T10194-1997	GB4943.1-2011 GB/T1093-1997 GB/T10194-1997 GB8898-2011
Title	Transient Voltage Surge Suppressors	Transient Voltage Surge Suppressors	Varistors for use in electronic equipment		Engaged in Voluntary Product Certification	
Certificate No.	VZCA2.E325508	VZCA8.E325508	40004658		CQC07001019159/9161/9162/9163/9164	
Symbols	☆		☆	★	☆	⊛



RATING AND CHARACTERISTICS
RATING AND CHARACTERISTICS -10mm

Part No.	Varistor Voltage at 1mA		Maximum Allowable Voltage		Maximum Clamping Voltage		Withstanding Surge Current (8/20us)	Nominal Discharge Current (8/20us)	Rated Wattage	Energy (10/1000us)	Certification
	DC (V)	Tolerance	AC rms (V)	DC (V)	V@ ic (V)	ic (A)					
JVC 10S 201K	200	±10%	130	170	340	25	3500	1.5	0.4	35.0	★ ★ ★
JVC 10S 221K	220	±10%	140	180	360	25	3500	1.5	0.4	39.0	★ ★ ★
JVC 10S 241K	240	±10%	150	200	395	25	3500	1.5	0.4	42.0	★ ★ ★
JVC 10S 271K	270	±10%	175	225	455	25	3500	1.5	0.4	49.0	★ ★ ★
JVC 10S 301K	300	±10%	195	250	505	25	3500	1.5	0.4	52.0	★ ★ ★
JVC 10S 331K	330	±10%	210	275	550	25	3500	1.5	0.4	58.0	★ ★ ★
JVC 10S 361K	360	±10%	230	300	595	25	3500	1.5	0.4	65.0	★ ★ ★
JVC 10S 391K	390	±10%	250	320	650	25	3500	1.5	0.4	70.0	★ ★ ★
JVC 10S 431K	430	±10%	275	350	710	25	3500	1.5	0.4	80.0	★ ★ ★
JVC 10S 471K	470	±10%	300	385	775	25	3500	1.5	0.4	85.0	★ ★ ★
JVC 10S 511K	510	±10%	320	418	842	25	3500	1.5	0.4	92.0	★ ★ ★
JVC 10S 561K	560	±10%	350	460	920	25	3500	1.5	0.4	102.0	★ ★ ★
JVC 10S 621K	620	±10%	385	505	1025	25	3500	1.5	0.4	107.0	★ ★ ★
JVC 10S 681K	680	±10%	420	560	1120	25	3500	1.5	0.4	112.0	★ ★ ★
JVC 10S 751K	750	±10%	460	615	1240	25	3500	1.5	0.4	115.0	★ ★ ★
JVC 10S 781K	780	±10%	485	640	1290	25	3500	1.5	0.4	116.0	★ ★ ★
JVC 10S 821K	820	±10%	510	670	1355	25	3500	1.5	0.4	118.0	★ ★ ★
JVC 10S 911K	910	±10%	550	745	1500	25	3500	1.5	0.4	127.0	★ ★ ★
JVC 10S 102K	1000	±10%	625	825	1650	25	3500	1.5	0.4	140.0	★ ★ ★
JVC 10S 112K	1100	±10%	680	895	1815	25	3500	1.5	0.4	155.0	★ ★ ★

過電壓保護

Pulse Life time Ratings-10mm
10S 201K~10S 471K

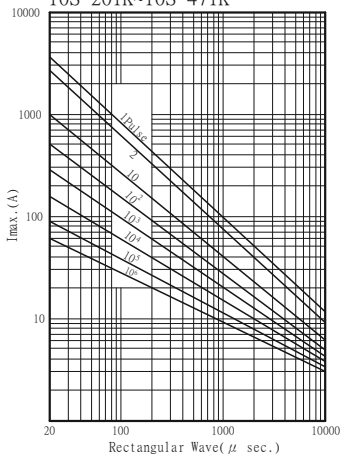

V-I Characteristic Curve-10mm
10S 201K~10S 471K

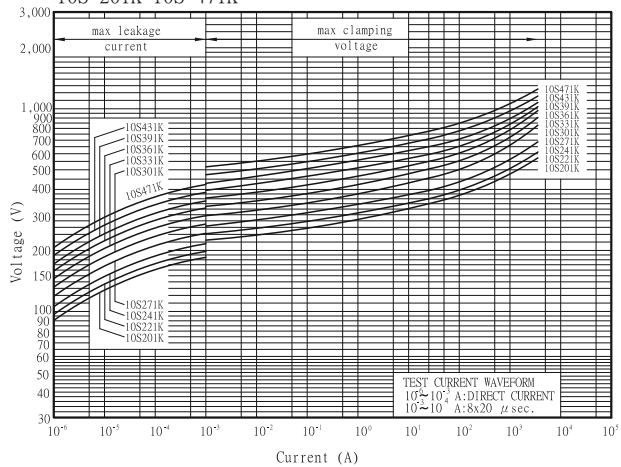

10S 511K~10S 112K

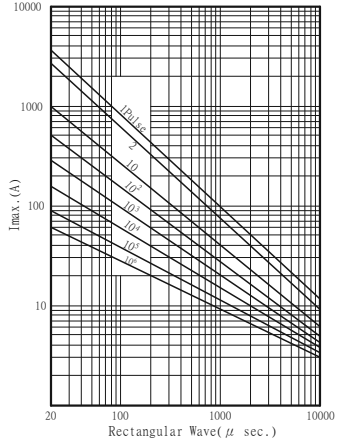

10S 511K~10S 112K

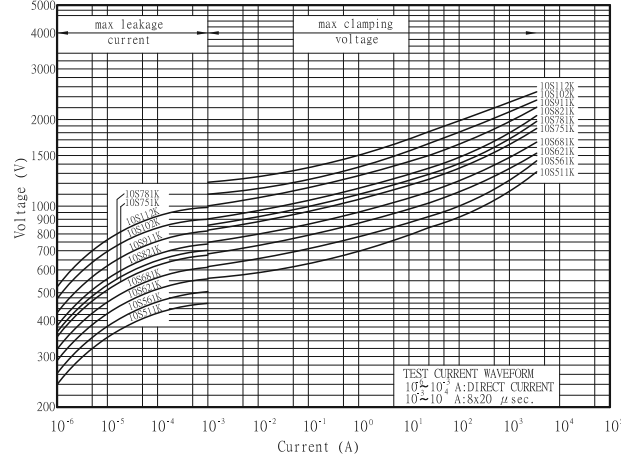



RATING AND CHARACTERISTICS
RATING AND CHARACTERISTICS - 12mm

Part No.	Varistor Voltage at 1mA		Maximum Allowable Voltage		Maximum Clamping Voltage		Withstanding Surge Current (8/20us)	Nominal Discharge Current (8/20us)	Rated Wattage (W)	Energy (10/1000us) (J)	Certification		
	DC (V)	Tolerance	AC rms (V)	DC (V)	V@ ic (V)	ic (A)					1 Time (A)	In (KA)	UL
JVC 12S 301K	300	±10%	195	250	505	25	5000	2	0.4	52.0	★	★	★
JVC 12S 331K	330	±10%	210	275	550	25	5000	2	0.4	58.0	★	★	★
JVC 12S 361K	360	±10%	230	300	595	25	5000	2	0.4	65.0	★	★	★
JVC 12S 391K	390	±10%	250	320	650	25	5000	2	0.4	70.0	★	★	★
JVC 12S 431K	430	±10%	275	350	710	25	5000	2	0.4	80.0	★	★	★
JVC 12S 471K	470	±10%	300	385	775	25	5000	2	0.4	85.0	★	★	★
JVC 12S 511K	510	±10%	320	418	842	25	5000	2	0.4	92.0	★	★	★
JVC 12S 561K	560	±10%	350	460	920	25	5000	2	0.4	102.0	★	★	★
JVC 12S 621K	620	±10%	385	505	1025	25	5000	2.0	0.4	107.0	★	★	★
JVC 12S 681K	680	±10%	420	560	1120	25	5000	2.0	0.4	112.0	★	★	★
JVC 12S 751K	750	±10%	460	615	1240	25	5000	2.0	0.4	115.0	★	★	★
JVC 12S 781K	780	±10%	485	640	1290	25	5000	2.0	0.4	116.0	★	★	★
JVC 12S 821K	820	±10%	510	670	1355	25	5000	2.0	0.4	118.0	★	★	★
JVC 12S 911K	910	±10%	550	745	1500	25	5000	2.0	0.4	127.0	★	★	★
JVC 12S 102K	1000	±10%	625	825	1650	25	5000	2.0	0.4	140.0	★	★	★
JVC 12S 112K	1100	±10%	680	895	1815	25	5000	2.0	0.4	155.0	★	★	★

過電壓保護

Pulse Life time Ratings-12mm

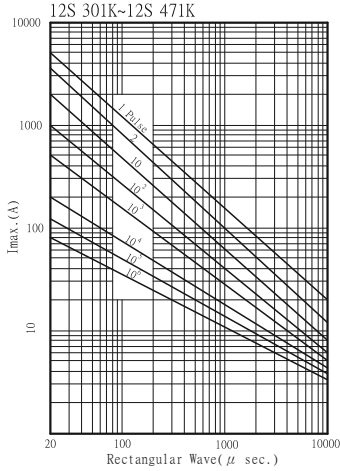

V-I Characteristic Curve-12mm

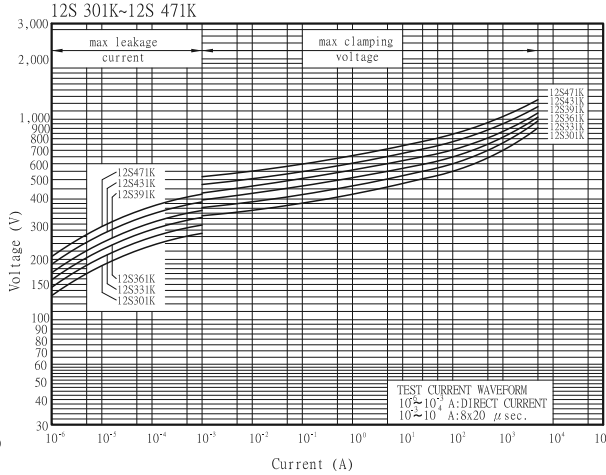

12S 511K-12S 112K

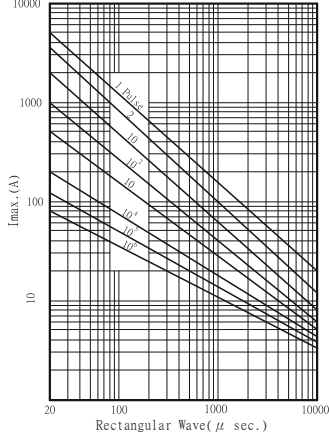

12S 511K-12S 112K

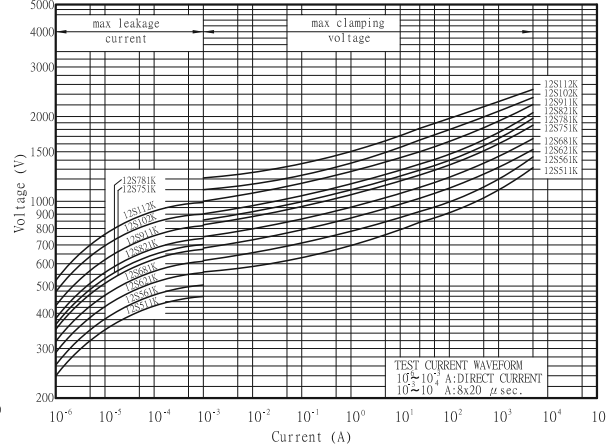



RATING AND CHARACTERISTICS
RATING AND CHARACTERISTICS - 14mm

Part No.	Varistor Voltage at 1mA		Maximum Allowable Voltage		Maximum Clamping Voltage		Withstanding Surge Current (8/20us)	Nominal Discharge Current (8/20us)	Rated Wattage	Energy (10/1000us)	Certification		
	DC (V)	Tolerance	AC rms (V)	DC (V)	V@ ic (V)	ic (A)	1 Time (A)	In (KA)	(W)	(J)	UL	CE	CCC
JVC 14S 201K	200	±10%	130	170	340	50	6000	3	0.6	70.0	★	★	★
JVC 14S 221K	220	±10%	140	180	360	50	6000	3	0.6	78.0	★	★	★
JVC 14S 241K	240	±10%	150	200	395	50	6000	3	0.6	84.0	★	★	★
JVC 14S 271K	270	±10%	175	225	455	50	6000	3	0.6	99.0	★	★	★
JVC 14S 301K	300	±10%	195	250	505	50	6000	3	0.6	105.0	★	★	★
JVC 14S 331K	330	±10%	210	275	550	50	6000	3	0.6	115.0	★	★	★
JVC 14S 361K	360	±10%	230	300	595	50	6000	3	0.6	130.0	★	★	★
JVC 14S 391K	390	±10%	250	320	650	50	6000	3	0.6	140.0	★	★	★
JVC 14S 431K	430	±10%	275	350	710	50	6000	3.0	0.6	155.0	★	★	★
JVC 14S 471K	470	±10%	300	385	775	50	6000	3.0	0.6	175.0	★	★	★
JVC 14S 511K	510	±10%	320	418	842	50	6000	3.0	0.6	190.0	★	★	★
JVC 14S 561K	560	±10%	350	460	920	50	6000	3.0	0.6	205.0	★	★	★
JVC 14S 621K	620	±10%	385	505	1025	50	6000	3.0	0.6	215.0	★	★	★
JVC 14S 681K	680	±10%	420	560	1120	50	6000	3.0	0.6	225.0	★	★	★
JVC 14S 751K	750	±10%	460	615	1240	50	6000	3.0	0.6	230.0	★	★	★
JVC 14S 781K	780	±10%	485	640	1290	50	6000	3.0	0.6	233.0	★	★	★
JVC 14S 821K	820	±10%	510	670	1355	50	6000	3.0	0.6	235	★	★	★
JVC 14S 911K	910	±10%	550	745	1500	50	6000	3.0	0.6	255.0	★	★	★
JVC 14S 102K	1000	±10%	625	825	1650	50	6000	3.0	0.6	283	★	★	★
JVC 14S 112K	1100	±10%	680	895	1815	50	6000	3.0	0.6	310	★	★	★

過電壓保護

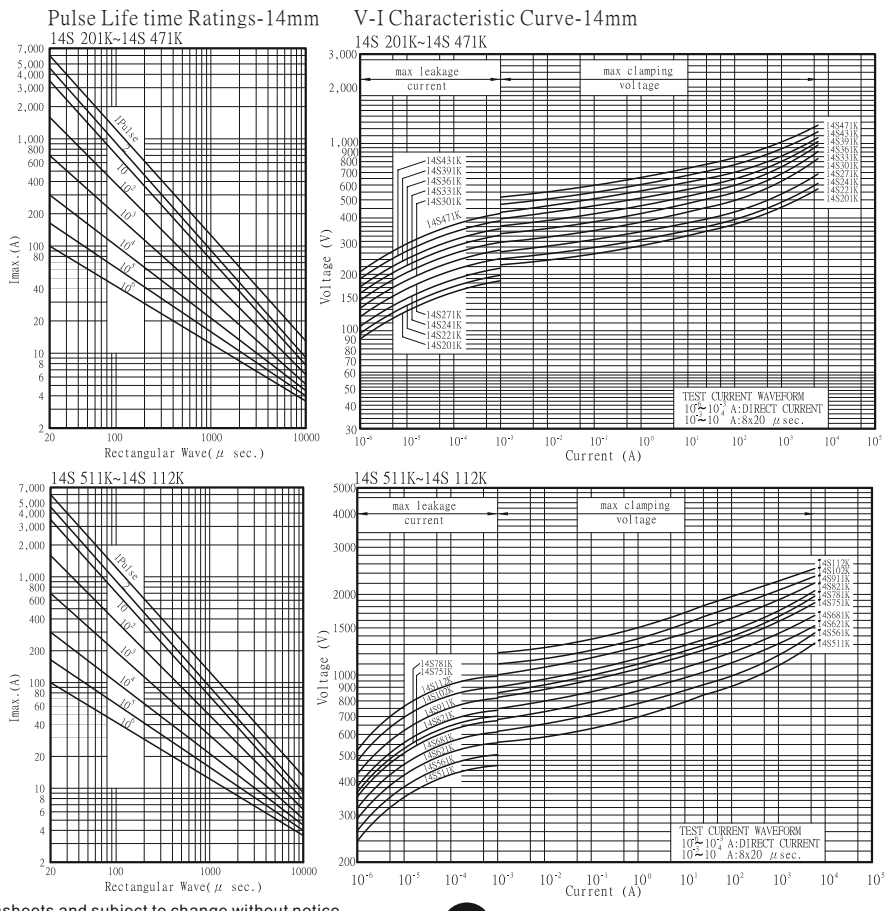

All specification is base on datasheets and subject to change without notice.



RATING AND CHARACTERISTICS
RATING AND CHARACTERISTICS -20mm

Part No.	Varistor Voltage at 1mA		Maximum Allowable Voltage		Maximum Clamping Voltage		Withstanding Surge Current (8/20us)	Nominal Discharge Current (8/20us)	Rated Wattage	Energy (10/1000us)	Certification
	DC (V)	Tolerance	AC rms (V)	DC (V)	V@ ic (V)	ic (A)					
JVC 20S 201K	200	±10%	130	170	340	100	10000	4	1	140.0	★ ★ ☆
JVC 20S 221K	220	±10%	140	180	360	100	10000	4	1	155.0	★ ★ ☆
JVC 20S 241K	240	±10%	150	200	395	100	10000	4	1	168.0	★ ★ ☆
JVC 20S 271K	270	±10%	175	225	455	100	10000	4	1	190.0	★ ★ ☆
JVC 20S 301K	300	±10%	195	250	505	100	10000	4	1	210.0	★ ★ ☆
JVC 20S 331K	330	±10%	210	275	550	100	10000	4	1	228.0	★ ★ ☆
JVC 20S 361K	360	±10%	230	300	595	100	10000	4	1	255.0	★ ★ ☆
JVC 20S 391K	390	±10%	250	320	650	100	10000	4	1	275.0	★ ★ ☆
JVC 20S 431K	430	±10%	275	350	710	100	10000	4.0	1	303.0	★ ★ ☆
JVC 20S 471K	470	±10%	300	385	775	100	10000	4.0	1	350.0	★ ★ ☆
JVC 20S 511K	510	±10%	320	418	842	100	10000	4.0	1	382.0	★ ★ ☆
JVC 20S 561K	560	±10%	350	460	920	100	10000	4.0	1	410.0	★ ★ ☆
JVC 20S 621K	620	±10%	385	505	1025	100	10000	4.0	1	420.0	★ ★ ☆
JVC 20S 681K	680	±10%	420	560	1120	100	10000	4.0	1	430.0	★ ★ ☆
JVC 20S 751K	750	±10%	460	615	1240	100	10000	4.0	1	440.0	★ ★ ☆
JVC 20S 781K	780	±10%	485	640	1290	100	10000	4.0	1	450.0	★ ★ ☆
JVC 20S 821K	820	±10%	510	670	1355	100	10000	4.0	1	460	★ ★ ☆
JVC 20S 911K	910	±10%	550	745	1500	100	10000	4.0	1	510.0	★ ★ ☆
JVC 20S 102K	1000	±10%	625	825	1650	100	10000	4.0	1	566	★ ★ ☆
JVC 20S 112K	1100	±10%	680	895	1815	100	10000	4.0	1	620	★ ★ ☆

過電壓保護

Pulse Life time Ratings-20mm
20S 201K~20S 471K

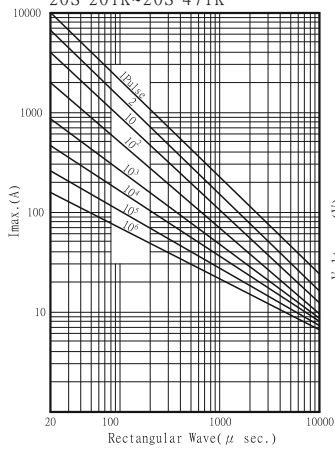

V-I Characteristic Curve-20mm
20S 201K~20S 471K

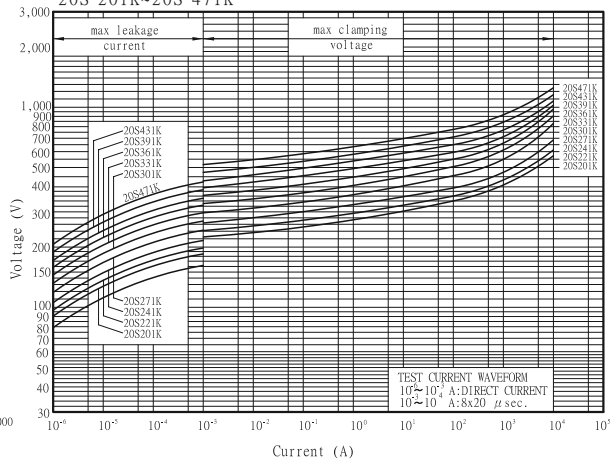

20S 511K~20S 112K

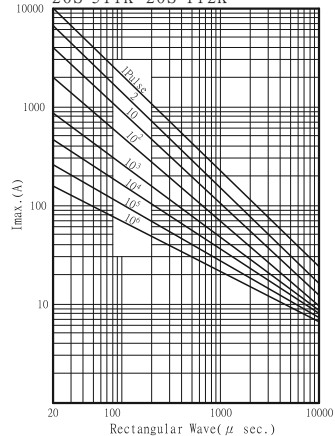

20S 511K~20S 112K

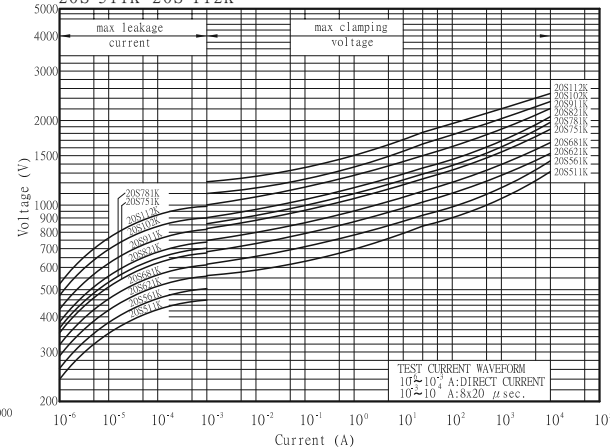



JOYIN CO., LTD

Metal Oxide Varistor

Reliability-JVC

Test description	Standard	Test condition	Test requirement						
Tensile Strength of Terminals	IEC60068-2-21	After gradually applying the load specified below and keeping the unit fixed for 10±1 seconds. <table border="1" style="margin-left: 20px;"> <tr> <td>Terminal diameter (mm)</td> <td>Force (Kg)</td> </tr> <tr> <td>0.5 < d ≤ 0.8</td> <td>1.0</td> </tr> <tr> <td>0.8 < d ≤ 1.25</td> <td>2.0</td> </tr> </table>	Terminal diameter (mm)	Force (Kg)	0.5 < d ≤ 0.8	1.0	0.8 < d ≤ 1.25	2.0	No visible damage ΔVb% ≤ ±5%
Terminal diameter (mm)	Force (Kg)								
0.5 < d ≤ 0.8	1.0								
0.8 < d ≤ 1.25	2.0								
Bending Strength of Terminals	IEC60068-2-21	Hold specimen and apply the force specified below to each lead. Bend the specimen to 90°, then return to the original position. Repeat the procedure in the opposite direction. <table border="1" style="margin-left: 20px;"> <tr> <td>Terminal diameter (mm)</td> <td>Force (Kg)</td> </tr> <tr> <td>0.5 < d ≤ 0.8</td> <td>0.5</td> </tr> <tr> <td>0.8 < d ≤ 1.25</td> <td>1.0</td> </tr> </table>	Terminal diameter (mm)	Force (Kg)	0.5 < d ≤ 0.8	0.5	0.8 < d ≤ 1.25	1.0	No visible damage ΔVb% ≤ ±5%
Terminal diameter (mm)	Force (Kg)								
0.5 < d ≤ 0.8	0.5								
0.8 < d ≤ 1.25	1.0								
Vibration	IEC60068-2-6	Frequency range : 10Hz~55Hz Amplitude : 0.75mm or 98 m/s ² Direction : 3 mutually perpendicular directions, 2hrs each.	No visible damage ΔVb% ≤ ±5%						
Solderability	IEC60068-2-20	Bath temperature : 245±3°C Immersion time : 3±0.3 sec	At least 95% of terminal electrode is covered by new solder						
Resistance to soldering heat	IEC60068-2-20	Bath temperature : 260±3°C Immersion time : 10±1 sec (5N series 5±0.5s)	No visible damage ΔVb(1mA) ≤ ±5%						
Voltage Proof	IEC61051-1	The specified voltage is applied between both terminals of the component connected together for 1 minute . <table border="1" style="margin-left: 20px;"> <tr> <td>2500Vrms(AC)</td> <td>Test Voltage(AC)</td> </tr> </table>	2500Vrms(AC)	Test Voltage(AC)	No visible damage				
2500Vrms(AC)	Test Voltage(AC)								
Rapid change of temperature	IEC60068-2-14	Temperature cycle shall be repeated 5 cycles 1. -40±3°C keeping 30±3min 2. Room temperature keeping 5±3min 3. 125±2°C keeping 30±3min 4. Room temperature keeping 5±3min	No visible damage ΔVb% ≤ ±5%						
Damp heat load	IEC60068-2-78	Temperature 40±2°C R.H.90~95% and the maximum Allowable voltage for 1000±24 hours	No visible damage ΔVb% ≤ ±10%						
Damp heat	IEC60068-2-78	Temperature 40±2°C R.H.90~95% for 1000±24 hours	No visible damage ΔVb% ≤ ±5%						
High temperature load	MIL-STD-202 Method 108	After being continuously applied the max allowable voltage at 85±2°C for 1000±24 hours	No visible damage ΔVb% ≤ ±10%						
High temperature storage	IEC60068-2-2	125±5°C for 1000±24 hours	No visible damage ΔVb% ≤ ±5%						
Low temperature storage	IEC60068-2-1	-40±2°C for 1000±24 hours	No visible damage ΔVb% ≤ ±5%						
Varistor Voltage Temp. Coefficient	Specification Standard	Measure V1mA at -40°C、25°C、125°C	-0.05 ≤ TC ≤ 0.05(%/°C)						
8/20μs Surge Life	IEC61051-1	8/20μs waveform, 10 surge current, unipolar, interval 30 secs, amplitude corresponding to max. surge current derating curves for 20μs.	No visible damage ΔVb% ≤ ±10%						
10/1000μs Surge Life	IEC61051-1	10/1000μs waveform, 10 surge current, unipolar, interval 2 mins, amplitude corresponding to max. surge current derating curves for 1000μs.	No visible damage ΔVb% ≤ ±10%						

過電壓保護

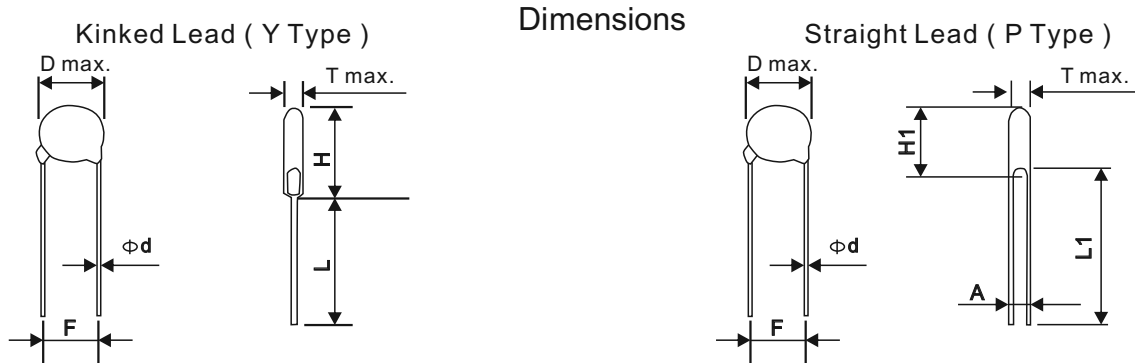

Dimensions

Dimensions Table

unit : mm

Diameter	5mm	7mm	10mm	14mm	20mm	25mm
D max.	7.5	9.0	12.5	16.5	23	29
d ± 0.05	0.6	0.6	0.8	0.8	1.0	1.0
F ± 1.0	5.0	5.0	7.5	7.5	10.0	10.0
H max.	11.0	12.5	17/*19	22/*23	28/*29	36
L1 min.	25.0	25.0	25.0	25.0	25.0	25.0
L min.	24.0	24.0	24.0	24.0	24.0	20.0

*Just for 182K

Table of T max, A&H1 max.

unit : mm

Diameter TypeNo.	5mm			7mm			10mm			14mm			20mm			25mm		
	T max.	A± 0.8	H1max.	T max.	A± 0.8	H1max.	T max.	A± 0.8	H1max.	T max.	A± 0.8	H1max.	T max.	A± 0.8	H1max.	T max.	A± 0.8	H1max.
180M	3.9	0.8	10.5	3.9	0.8	12.0	4.3	0.8	15.0	4.3	0.9	19.5	/	/	/	/	/	/
220M/L	4.1	0.9	10.5	4.1	0.9	12.0	4.5	0.9	15.0	4.5	1.0	19.5	4.9	1.0	26.5	/	/	/
270M/K	4.3	0.9	10.5	4.3	0.9	12.0	4.7	0.9	15.0	4.7	1.0	19.5	5.1	1.1	26.5	/	/	/
330M/K	4.5	1.0	10.5	4.5	1.0	12.0	4.9	1.0	15.0	4.9	1.2	19.5	5.3	1.2	26.5	/	/	/
390L/K	4.5	1.2	10.5	4.5	1.2	12.0	5.1	1.2	15.0	5.1	1.4	19.5	5.4	1.4	26.5	/	/	/
470L/K	4.8	1.2	10.5	4.8	1.2	12.0	5.3	1.2	15.0	5.4	1.4	19.5	5.6	1.4	26.5	/	/	/
560L/K	4.8	1.4	10.5	4.8	1.4	12.0	5.5	1.4	15.0	5.6	1.6	19.5	5.6	1.6	26.5	/	/	/
680L/K	5.1	1.7	10.5	5.1	1.7	12.0	5.7	1.6	15.0	5.6	1.9	19.5	5.9	1.9	26.5	/	/	/
820K	3.8	0.8	10.5	3.8	0.8	12.0	4.3	0.8	15.0	4.3	1.0	19.5	4.7	1.1	26.5	/	/	/
101K	3.9	0.8	10.5	3.9	0.8	12.0	4.4	0.8	15.0	4.5	1.0	19.5	4.9	1.2	26.5	/	/	/
121K	4.1	0.9	10.5	4.1	0.9	12.0	4.5	0.9	15.0	4.6	1.1	19.5	5.1	1.3	26.5	/	/	/
151K	4.5	1.2	10.5	4.5	1.2	12.0	4.9	1.2	15.0	5.0	1.4	19.5	5.4	1.6	26.5	/	/	/
181K	3.9	1.0	10.5	3.9	1.0	12.0	4.3	1.0	15.0	4.3	1.2	19.5	5.0	1.4	26.5	/	/	/
201K	4.0	1.0	10.5	4.0	1.0	12.0	4.4	1.0	15.0	4.4	1.2	19.5	5.1	1.4	26.5	5.4	2.5	35
221K	4.0	1.1	10.5	4.0	1.1	12.0	4.4	1.1	15.0	4.4	1.3	19.5	5.2	1.5	26.5	5.6	2.6	35
241K	4.2	1.1	10.5	4.2	1.3	12.0	4.6	1.3	15.0	4.6	1.5	19.5	5.3	1.7	26.5	5.7	2.8	35
271K	4.4	1.3	10.5	4.4	1.4	12.0	4.8	1.4	15.0	4.8	1.5	19.5	5.5	1.9	26.5	6.0	3.0	35
301K	4.4	1.3	10.5	4.4	1.5	12.0	4.8	1.6	15.0	4.8	1.7	19.5	5.7	2.1	26.5	6.3	3.2	35
331K	4.5	1.3	10.5	4.5	1.5	12.0	4.9	1.6	15.0	4.9	1.7	19.5	5.8	2.1	26.5	6.6	3.4	35
361K	4.7	1.8	10.5	4.6	1.9	12.0	5.0	1.9	15.0	5.0	2.1	19.5	6.0	2.3	26.5	6.8	3.6	35
391K	4.8	2.0	11.0	4.8	2.0	12.5	5.2	2.2	15.0	5.2	2.2	19.5	6.2	2.4	26.5	7.1	3.9	35
431K	5.1	2.1	11.0	5.1	2.0	12.5	5.5	2.5	15.0	5.5	2.5	19.5	6.6	2.7	26.5	7.2	3.3	35
471K	5.2	2.2	11.0	5.2	2.3	12.5	5.6	2.6	15.0	5.6	2.7	19.5	6.8	2.9	27.0	7.4	3.5	35
511K	5.6	2.5	11.5	5.6	2.5	12.5	5.8	3.1	15.0	5.8	3.1	20.0	7.0	3.3	27.0	7.6	3.8	35
561K	5.7	2.8	11.5	5.7	2.8	12.5	6.1	3.4	15.0	6.1	3.4	20.0	7.3	3.6	27.0	7.9	4.0	35
621K	6.0	3.1	11.5	6.0	3.1	12.5	6.4	4.0	15.0	6.4	3.8	20.0	7.6	4.1	27.0	8.2	4.4	35
681K	6.3	3.4	11.5	6.3	3.4	12.5	6.8	4.4	15.0	6.8	4.1	20.0	8.0	4.4	27.0	8.3	4.7	35
751K	6.7	3.7	11.5	6.8	3.7	12.5	7.2	4.4	15.0	7.2	4.3	20.0	8.4	4.5	27.0	8.7	5.0	35
781K	/	/	/	7.0	3.9	12.5	7.3	4.6	15.0	7.3	4.6	20.0	8.6	4.8	27.0	8.9	5.2	35
821K	/	/	/	7.2	4.1	12.5	7.6	4.6	15.0	7.6	4.6	20.0	8.8	4.8	27.0	9.1	5.4	35
911K	/	/	/	/	/	/	8.2	5.4	16.0	8.2	5.4	20.5	9.3	5.7	27.0	9.6	5.9	35
102K	/	/	/	/	/	/	8.5	5.4	16.0	8.6	5.6	20.5	9.9	5.8	27.0	/	/	/
112K	/	/	/	/	/	/	9.1	5.7	16.0	9.1	6.1	20.5	10.3	6.3	27.0	/	/	/
122K	/	/	/	/	/	/	9.9	6.3	17.0	10.0	6.7	21.0	11.3	6.9	27.5	/	/	/
142K	/	/	/	/	/	/	10.7	7.4	17.5	10.9	7.8	21.5	12.8	8.0	28.0	/	/	/
162K	/	/	/	/	/	/	11.5	8.6	17.5	11.8	9.0	21.5	13.0	9.2	28.5	/	/	/
182K	/	/	/	/	/	/	12.6	9.8	17.5	12.8	10.2	21.5	13.5	10.4	29.0	/	/	/

過電壓保護

Tape and Reel Dimensions

1/2" pitch

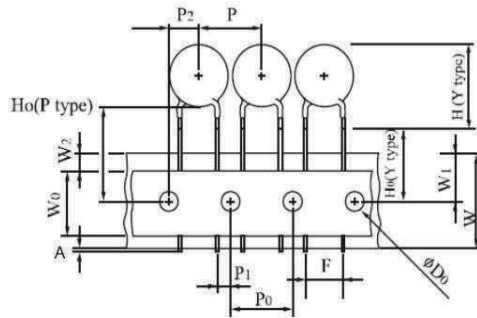

1.0" pitch

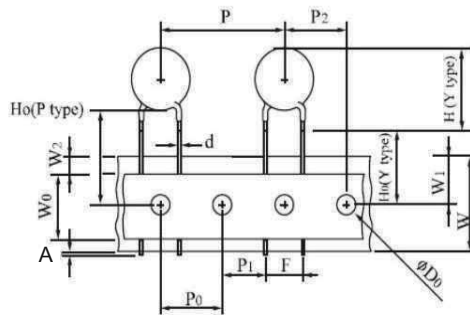

Symbols	Item	5/ 7 mm	10/ 14 mm	20 mm
A	Cut out length	1.1 mm max.	1.1 mm max.	
H (Y type)	Height of Top	See H max. table		
H0(Y type)	Height to seating plane	16.0 ± 0.5 mm (* ± 1.0 mm)	16.0 ± 0.5mm (* ± 1.0 mm)	
H0(P type)	Height of component from hole center	16.0 ~ 21.0 mm	16.0~ 21.0 mm	
Δh	Front to back deviation	0 ± 2.0 mm	0 ± 2.0 mm	
W	Carrier tape width	18 ^{+1.0} _{-0.5} mm	18 ^{+1.0} _{-0.5} mm	
W0	Hold down tape width	10.0 mm	12.0 mm	
W1	Sprocket hole position	9.0 ^{+0.75} _{-0.5} mm	9.0 ^{+0.75} _{-0.5} mm	
W2	Adhesive tape position	3.0 mm max.	3.0 mm max.	
F	Component lead spacing	5.0 ± 1.0 mm	7.5 ± 1.0 mm	10.0 ± 1.0 mm
P	Pitch of component	12.7 ± 1.0 mm	25.4 ± 1.0 mm	
P0	Sprocket hole pitch	12.7 ± 0.3 mm	12.7 ± 0.3 mm	
P1	Lead length from hole center to lead	3.85 ± 0.7 mm	8.95 ± 0.7 mm	7.7 ± 0.7 mm
P2	Length from hole center to disk center	6.35 ± 1.3 mm	12.7 ± 1.3 mm	
D0	Sprocket hole diameter	4.0 ± 0.2 mm	4.0 ± 0.2 mm	
d	Lead wire diameter	0.6 ± 0.05 mm	0.8 ± 0.05 mm	1.0 ± 0.05 mm
T	Disk thickness	See Tmax. table	See T max. table	
t1	Total thickness tape	0.7 ± 0.05 mm	0.7 ± 0.05 mm	
t2	Total thickness	1.6 mm max.	1.8 mm max.	

Marking & packaging

MARKING

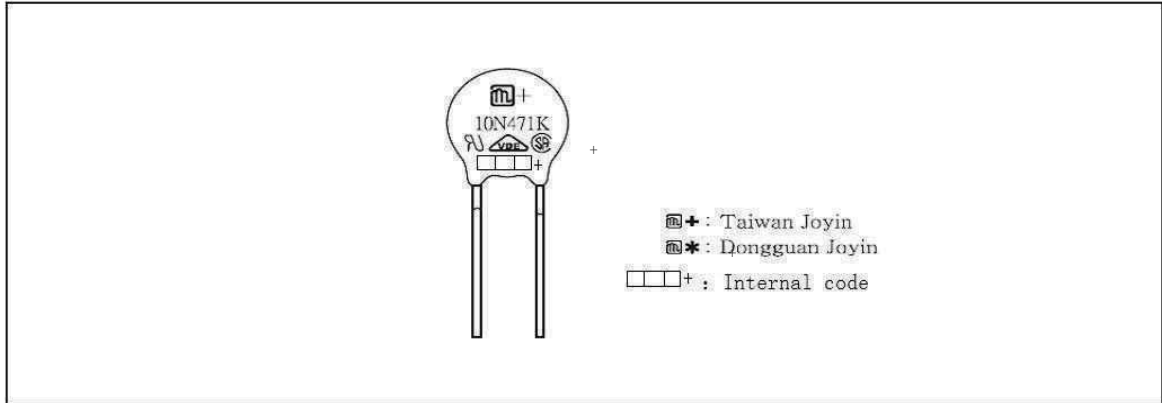

PACKAGING

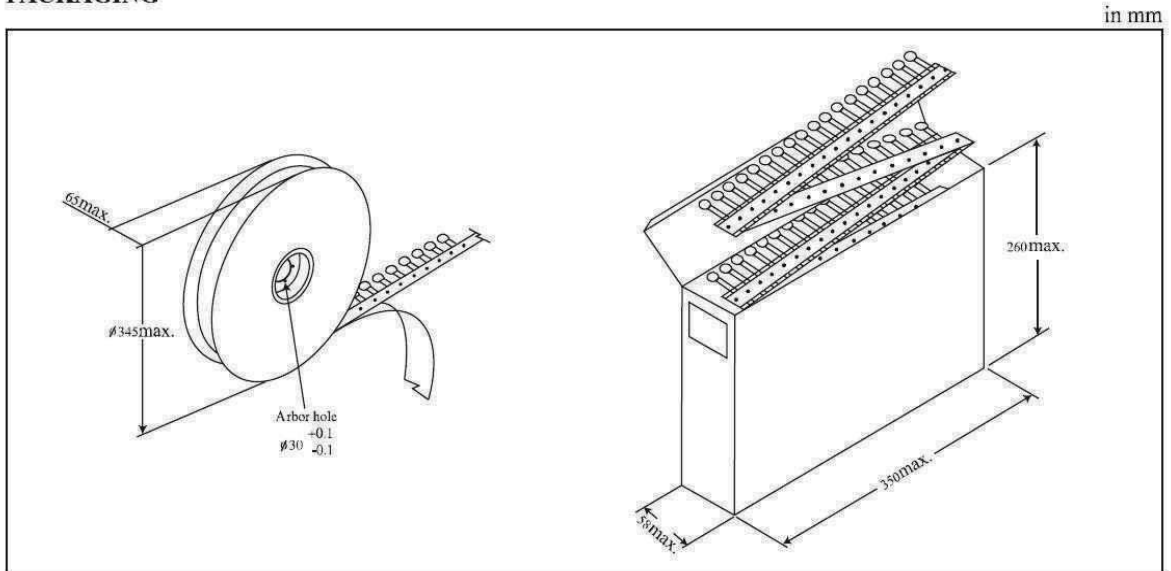

Quantity per Packing Unit

in Pcs

Series Part No.	5 mm			7 mm			10 mm			14 mm			20 mm			25mm
	Bulk (Box)	Reel	Ammo	Bulk (Box)	Reel	Ammo	Bulk (Box)	Reel	Ammo	Bulk (Box)	Reel	Ammo	Bulk (Box)	Reel	Ammo	Bulk (Box)
180M~470K	5000	1500	1500	5000	1500	1500	2500	1000	500	1500	750	500	750	500	500	-
560K~680K	5000	1500	1000	5000	1500	1000	2500	1000	500	1500	750	500	750	500	500	-
820K~391K	5000	1500	1500	5000	1500	1500	2500	1000	500	1500	750	500	750	500	500	750
431K~471K	5000	1500	1000	5000	1000	1000	2000	750	500	1500	750	500	750	500	500	750
511K~821K	4000	1000	1000	4000	1000	1000	1500	500	500	750	500	500	450	500	500	450
911K~122K	-	-	-	-	-	-	1500	500	350	750	500	350	450	-	-	450
142K~182K	-	-	-	-	-	-	750	-	-	450	-	-	300	-	-	-

Packaging	Bulk (Box)	Reel	Reel (14 mm, 20 mm)	Ammo (5 mm, 7 mm)	Ammo (10 mm, 14 mm)	Ammo (20 mm)
Box size (mm)	290×155×110	350×350×105	346×346×72	335×245×43	347×246×50	348×255×60
Carton size (mm)	328×310×250	370×370×590	370×370×468	515×354×258	515×364×246	535×365×275
One carton with	4 Boxes	5 Boxes (10 reels)	6 Boxes (6 reels)	10 Boxes	8 Boxes	8 Boxes